

Cerberus™ PRO

Fire detection system

FS720



Modular, networkable fire detection system for detection, evaluation, sounding an alarm, and extinguishing in the event of a fire.

- Control panel range with 5 types of station
- Networking via C-WEB/SAFEDLINK
- Extended networks via C-WEB/LAN backbone
- Powerful peripherals
- Optional, integrated extinguishing control
- Time-saving functions for mounting, commissioning, and service
- Optimum use of customer resources
- High availability
- Easy handling
- High speed

System overview



The diagrams have been simplified and do not include additional network hardware or security components. Permissible applications are described in the A6V101039439 Network Security Guidelines document. Contact your Siemens IT security expert for more information.

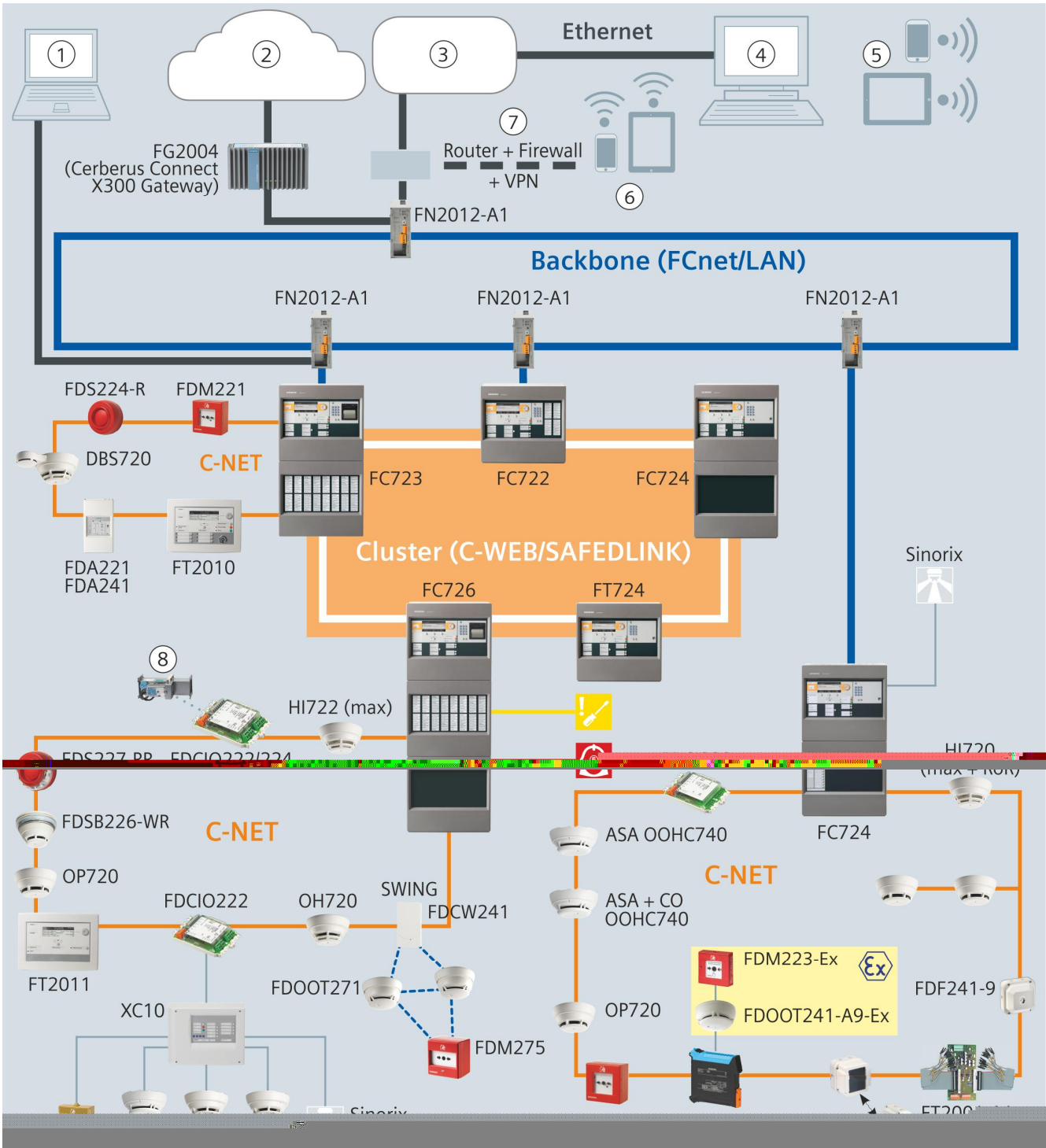

System overview

Features and Functions

- Control panel range with 5 types of station
 - Microprocessor-controlled fire detection system
 - Compact and modular fire control panels for between 252 and 1512 addresses
 - PC-based operation (Cerberus-Remote) via Fast Ethernet
 - Integrated BACnet interface
 - Free control logic
 - Phased evacuation
- C-WEB/SAFEDLINK networking
 - Redundant networking
 - Increased security thanks to degraded mode function
 - Fast data transfer of up to 315 kbit/s
 - Maximum of 32 stations
- Extended networks via an Ethernet backbone (C-WEB/LAN)
 - Heterogeneous networks via Industrial Ethernet (fiber-optic)
 - EN 54-compliant
 - Redundant data transmission
 - Up to 14 sub-nets with up to 16 stations per sub-net
 - Up to 64 stations in the entire network
 - Up to 32000 addresses
- Powerful peripherals
 - Acoustic alarm sounders, floor repeater displays/terminals supplied via bus
 - All FD720 devices are supported
- Time-saving functions for mounting, commissioning, and service
 - Ergonomic engineering tool (Cerberus-Engineering-Tool) featuring familiar Windows mechanisms
 - Auto-configuration (self-addressing)
 - Zones and customer texts can be assigned without hardware read-in
 - Remote transmission of diagnosis data (e.g., firmware versions)

Optimum use of customer resources

- Individual control panels or an entire network can be operated from a customer PC using the 'Cerberus-Remote' visualization software
- Redundancy cabling replaced by fail-safe network nodes
- Floor repeater display and terminals operated on the C-NET detector line

High availability

- Remote access via GAP or cloud
- Efficient troubleshooting thanks to remote transmission of diagnosis data
- Maximum reliability and secure detection
- Auto-configuration for primary site protection

Easy handling

- Easy and time-saving operation thanks to user-friendly and self-explanatory menu structure
- Efficient mounting, commissioning, and configuration thanks to pre-assembled control panels
- All system devices can be accessed remotely via a network device
- Download of the topology, consisting of periphery and installation, in the Engineering Tool
- Minimal training overheads thanks to an integrated operating and hardware concept and the 'Cerberus-Engineering-Tool' Engineering Tool for the entire system

High speed

- Data transmission rate of 315 kbit/s in fail-safe sub-net and 100 Mbit/s in a backbone Ethernet network
- Short download and upload times
- Logical configuration data created prior to site installation

General functional principle

The FD720 fire detectors identify fire phenomena, compare and evaluate them on the basis of stored patterns, and then transmit a signal to the fire control panel if they detect a fire. The fire control panel evaluates these signals and triggers individually configured fire controls, evac. controls, and, if available, integrated extinguishing controls.

In the event of faults, degraded mode safeguards the operation of those parts of the system that are detrimentally affected by the fault. All signals transmitted to the fire control panel or sent by the fire control panel are automatically displayed on the Person Machine Interface of the fire control panel according to where they originate and can be dealt with by means of operating functions.

The fire control panel saves all messages in the event memory together with a time stamp so that the source of the fire can be determined at a later point.

System Applications

FS720 is a modular, networkable fire detection system for detection, evaluation, and sounding an alarm in the event of a fire.

Due to its high flexibility and interconnectivity, the application spectrum of the FS720 fire detection system ranges from small hotels, restaurants, and workshops to extremely large applications with special requirements for availability and redundancy, such as airports, shopping malls, and large industrial plants.

The option to seamlessly integrate an automated extinguishing system into the fire detection system completes the application spectrum.

Networking of fire control panels



The diagrams have been simplified and do not include additional network hardware or security components. Permissible applications are described in the A6V101039439 Network Security Guidelines document. Contact your Siemens IT security expert for more information.

Up to 32 control panels and terminals can be linked to form one C-WEB network. If the C-WEB network is connected to a danger management system via BACnet, up to 16 control panels and terminals can be networked.

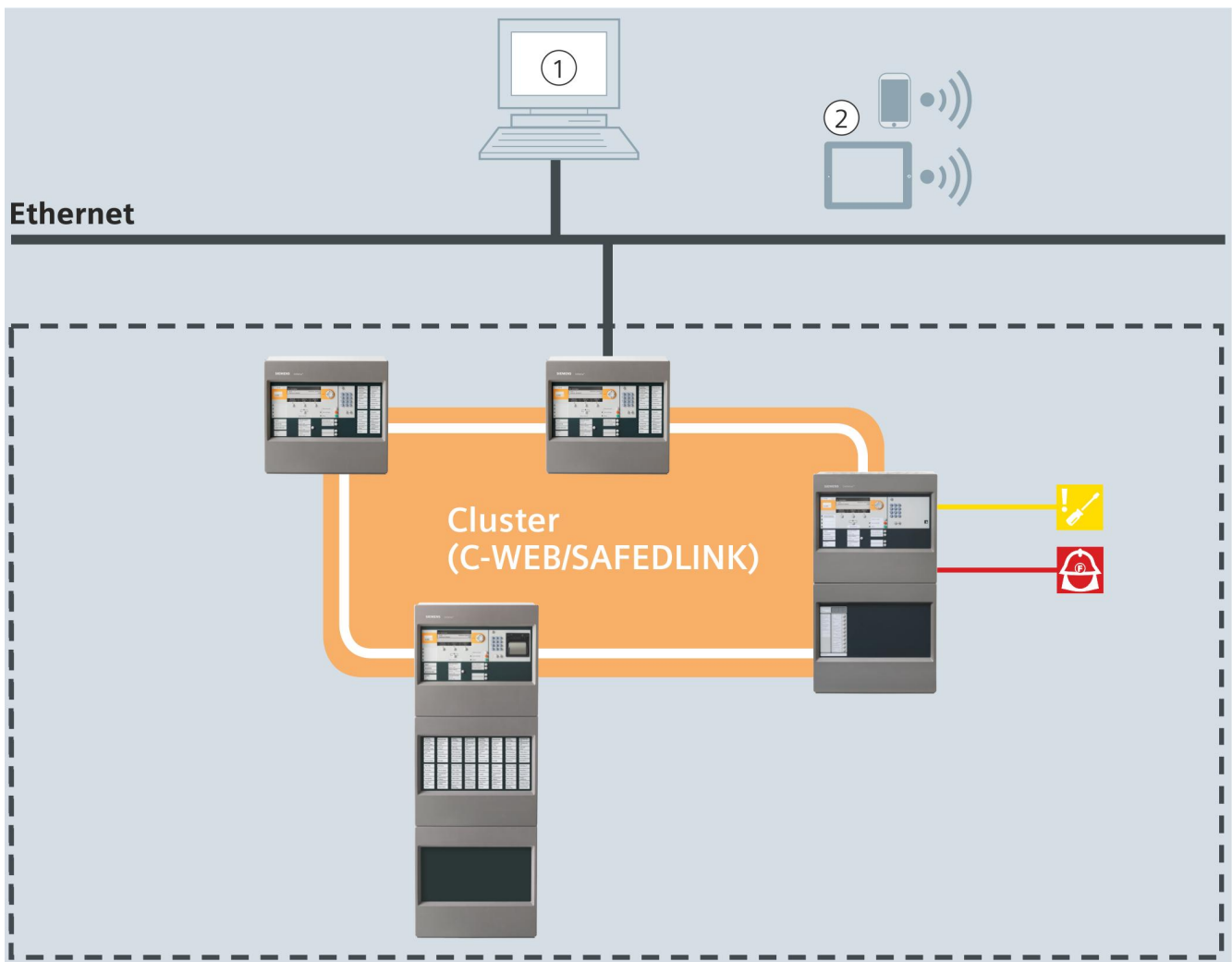

Sub-net

| | |
|---|--------------------------------------|
| 1 | Management platform |
| 2 | Remote access to management platform |
| | Transmission of a fault signal |
| | Transmission of an alarm signal |

An optical C-WEB/LAN network allows up to 14 sub-nets with up to 16 stations to be operated in one network. A maximum of 64 stations is supported in total.

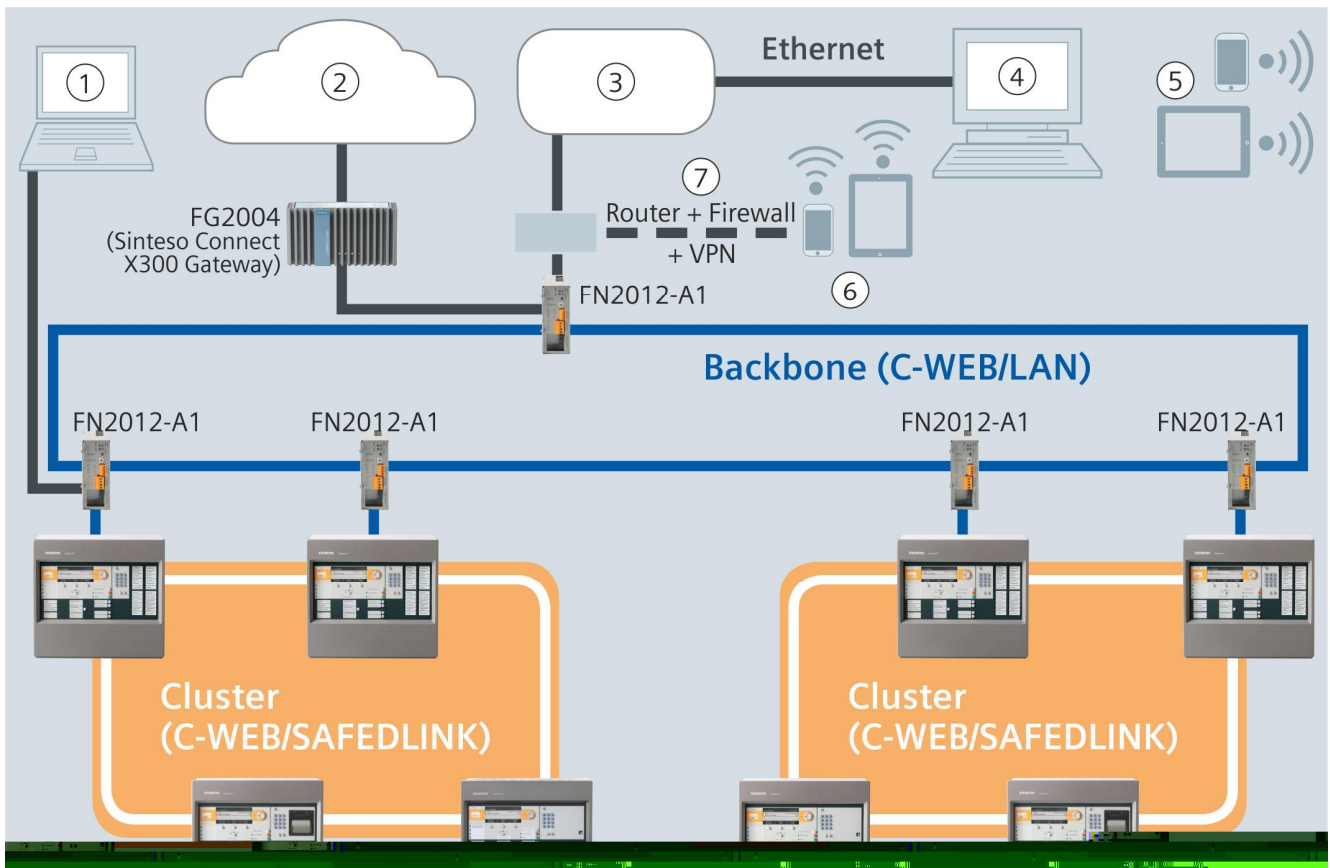

Backbone

| | |
|---|---|
| 1 | Remote access with Cerberus-Remote |
| 2 | FS cloud applications |
| 3 | Customer network |
| 4 | Management platform |
| 5 | Remote access to management platform |
| 6 | Remote access with Cerberus Mobile |
| 7 | Router + firewall + virtual private network |
| | Transmission of a fault signal |
|  | Transmission of an alarm signal |

You will find a detailed labeled version of the diagram above along with further information in the A6V10332842 planning guide, see chapter 'Product documentation'.

Cross-station features and functions

- Fast Ethernet interface for a heterogeneous network
- Processes signals from Cerberus PRO as well as from earlier detector series
- Siemens danger management system can be connected
- Slots for RS232 and RS485 serial interfaces
- Floor repeater devices, alarm devices, and mimic displays on the C-NET detector line
- All detector lines are monitored for ground faults.
- Integrated degraded mode function
- Freely configurable, time-dependent controls with optional weekly switching programs
- Time and situation-dependent changeover of detector parameter sets
- Controls for synchronous activation of sounders / sounder bases with signal sound, flash, and voice output
- The control panel and the fire detection system are custom-configured using the 'Cerberus-Engineering-Tool' software
- Firmware for all processor-controlled control panel components can be updated
- Customer texts can be adapted directly on the operating unit of the control panel or with the 'Cerberus-Engineering-Tool' software
- Up to 13000 events can be called up from the event memory and filtered based on various criteria
- Automatic summer/normal time changeover

FC722



You will find information on the integrated extinguishing system and the individual extinguishing components that are available in a separate data sheet with the document ID 'A6V10880701'.

| FC722-ZZ | Housing (Standard) |
|---|--|
|  | <p>Detector line (C-NET)</p> <ul style="list-style-type: none"> • 252 addresses • 2 loops/4 stubs <p>Properties</p> <ul style="list-style-type: none"> • Operating unit • 70 W power supply • Max. battery capacity 12 Ah <p>Options of the operating unit</p> <ul style="list-style-type: none"> • Event printer FTO2001-A1 • Key switch (Kaba) FTO2005-C1 • Key switch (nordic) FTO2006-B1 |

| | |
|---|---|
| FC722-YZ | Housing (Standard) |
|  | <p>Detector line (C-NET)</p> <ul style="list-style-type: none"> • 252 addresses • 2 loops/4 stubs <p>Properties</p> <ul style="list-style-type: none"> • Operating unit (+LED indicator) • 70 W power supply • Max. battery capacity 12 Ah <p>Options of the operating unit</p> <ul style="list-style-type: none"> • Key switch (Kaba) FTO2005-C1 • Key switch (nordic) FTO2006-B1 |

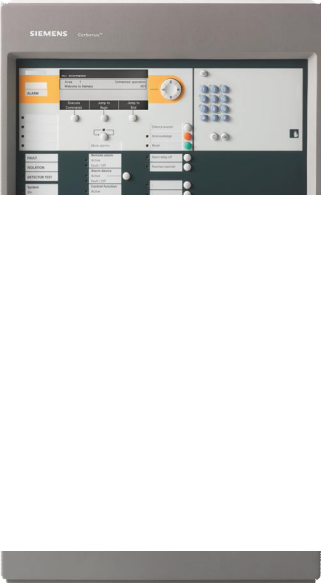
| | |
|--|--|
| FC722-ZA | Housing (Comfort) |
|  | <p>Detector line (C-NET)</p> <ul style="list-style-type: none"> • 252 addresses • 2 loops/4 stubs <p>Properties</p> <ul style="list-style-type: none"> • Operating unit • Operating add-on (empty) • 150 W power supply • Max. battery capacity 25 Ah • 1 flooding zone (optional) <p>Options of the operating unit</p> <ul style="list-style-type: none"> • Event printer FTO2001-A1 • Key switch (Kaba) FTO2005-C1 • Key switch (nordic) FTO2006-B1 • Operating add-on (2xLED indicator) FCM7213-Y3 • Operating add-on (4xLED indicator) FCM7214-Y3 • Exting. terminal (1 sector) XCM2002-A2 • Exting. terminal (4 sectors) XCM2003-A2 |

| | |
|---|---|
| FC722-ZE | Housing (Comfort) |
|  | <p>Detector line (C-NET)</p> <ul style="list-style-type: none"> • 252 addresses • 2 loops/4 stubs <p>Properties</p> <ul style="list-style-type: none"> • Operating unit • Operating add-on (2xLED indicator) • 150 W power supply • Max. battery capacity 25 Ah <p>Options of the operating unit</p> <ul style="list-style-type: none"> • Event printer FTO2001-A1 • Key switch (Kaba) FTO2005-C1 • Key switch (nordic) FTO2006-B1 |

FC723

| FC723-ZA | Housing (Comfort) |
|---|---|
|  | <p>C-NET detector line:</p> <ul style="list-style-type: none">• 756 addresses• 2 loops/4 stubs• Can be extended with 2 module bus cards <p>Installable module bus cards (option):</p> <ul style="list-style-type: none">• Line card (FDnet/C-NET) FCL2001-A1• Line card (SynoLOOP) FCL7201-Z3• I/O card (programmable) FCI2008-A1• I/O card (horn/monitored) FCI2009A1• I/O card (remote transmission) FCI2007-A1 <p>Features:</p> <ul style="list-style-type: none">• Operating unit• Operating add-on (empty)• Card cage (2 slots)• 150 W power supply• Max. battery capacity 25 Ah <p>Operating unit options:</p> <ul style="list-style-type: none">• Event printer FTO2001-A1• Key switch (Kaba) FTO2005-C1• Key switch (nordic) FTO2006-B1• Operating add-on (2xLED indicator) FCM7213-Y3• Operating add-on (4xLED indicator) FCM7214-Y3 |

FC724



You will find information on the integrated extinguishing system and the individual extinguishing components that are available in a separate data sheet with the document ID 'A6V10880701'.

| FC724-ZA | Housing (Comfort) |
|---|---|
|  | <p>C-NET detector line:</p> <ul style="list-style-type: none">• 504 addresses• 4 loops/8 stubs <p>Features:</p> <ul style="list-style-type: none">• Operating unit• Operating add-on (empty)• 150 W power supply• Max. battery capacity 25 Ah• 1 flooding zone (optional) <p>Operating unit options:</p> <ul style="list-style-type: none">• Event printer FTO2001-A1• Key switch (Kaba) FTO2005-C1• Key switch (nordic) FTO2006-B1• Operating add-on (2xLED indicator) FCM7213-Y3• Operating add-on (4xLED indicator) FCM7214-Y3• Exting. terminal (1 sector) XCM2002-A2 |

| FC724-ZE | Housing (Comfort) |
|--|---|
|  <p>The image shows the Siemens FC724-ZE fire alarm control panel. It features a large, multi-line LCD display at the top showing various status indicators and a keypad below it. The panel is housed in a grey, industrial-grade enclosure.</p> | <p>C-NET detector line:</p> <ul style="list-style-type: none"> • 504 addresses • 4 loops/8 stubs <p>Features:</p> <ul style="list-style-type: none"> • Operating unit • Operating add-on (2xLED indicator) • 150 W power supply • Max. battery capacity 25 Ah <p>Operating unit options:</p> <ul style="list-style-type: none"> • Event printer FTO2001-A1 • Key switch (Kaba) FTO2005-C1 • Key switch (nordic) FTO2006-B1 |

FC726

| FC726-ZA | Housing (Large) |
|--|---|
|  <p>The image shows the Siemens FC726-ZA fire alarm control panel. It has a large, multi-line LCD display at the top and a keypad below it. The panel is housed in a grey, industrial-grade enclosure with a larger footprint than the FC724-ZE model.</p> | <p>C-NET detector line:</p> <ul style="list-style-type: none"> • Max. 1512 addresses • 4 loops/8 stubs • Can be extended up to 28 loops/56 stubs <p>Extra module bus cards (option):</p> <ul style="list-style-type: none"> • Line card (FDnet/C-NET) FCL2001-A1 • Line card (SynoLOOP) FCL7201-Z3 • I/O card (programmable) FCI2008-A1 • I/O card (horn/monitored) FCI2009A1 • I/O card (remote transmission) FCI2007-A1 <p>Features:</p> <ul style="list-style-type: none"> • Operating unit • Operating add-on (empty) • Card cage (5 slots) • 150 W power supply • Max. battery capacity 45 Ah <p>Operating unit options:</p> <ul style="list-style-type: none"> • Event printer FTO2001-A1 • Key switch (Kaba) FTO2005-C1 • Key switch (nordic) FTO2006-B1 • Operating add-on (2xLED indicator) FCM7213-Y3 • Operating add-on (4xLED indicator) FCM7214-Y3 |

FT724

- Person Machine Interface that is used remotely from the control panel, which can be optionally provided with its own power supply
- Up to five fire terminals can be configured with system-wide visibility.
- The fire terminal has spaces for installing optional interfaces such as an RS232 or RS485, network modules (SAFEDLINK), and a key switch.
- Each fire terminal has an Ethernet connection.
- The powerful C-WEB can be used to network up to 64 fire control panels FC72x and fire terminals with one another in any way.
- Siemens danger management system can be connected

| FT724-ZZ | Housing (Eco) |
|---|---|
|  | <p>C-NET detector line:</p> <ul style="list-style-type: none">• None <p>Features:</p> <ul style="list-style-type: none">• Operating unit <p>Station options:</p> <ul style="list-style-type: none">• 70 W power supply• 2 batteries, each 7 Ah <p>Operating unit options:</p> <ul style="list-style-type: none">• Event printer FTO2001-A1• Key switch (Kaba) FTO2005-C1• Key switch (nordic) FTO2006-B1 |

FC722

This fire control panel is ideal for smaller applications, e.g., for use in workshops or hotels. Thanks to the flexible networking options, the Station can also be used for large-scale sites.

FC723

This fire control panel is ideal for medium-sized applications, e.g., for use in industrial plants, regional banks, or office complexes.
Within the context of modernization, the Station allows a gradual and seamless transition from older systems to Cerberus PRO.

FC724

This fire control panel is ideal for medium-sized applications, e.g., for use in industrial plants, regional banks, or office complexes.
Thanks to the flexible networking options, the Station can also be used for large-scale sites.

FC726

This fire control panel is ideal for large applications, e.g., for use in industrial plants, office complexes, or production halls.
Within the context of modernization, the Station allows a gradual and seamless transition from older systems to Cerberus PRO.

FT724

The fire terminal is designed for remote operation of a fire detection system, e.g., on one floor.

Application matrix





| Use | FC722 | FC723 | FC724 | FC726 | FT724 |
|---|-------|-------|-------|-------|-------|
| Smaller applications , such as workshops or hotels | ● | ○ | ● | ○ | — |
| Medium-sized applications , such as medium-sized industrial plants, regional banks, or medium-sized office blocks | ○ | ● | ● | ○ | — |
| Large applications , such as industrial plants, large office blocks, or production halls | ○ | ○ | ○ | ● | — |
| Large applications with high redundancy requirements , such as airports, power generation facilities, and shopping malls | — | — | — | ○ | — |
| Integrable extinguishing | ● | — | ● | — | — |
| Modernization of existing fire detection installations | — | ● | — | ● | — |
| Scalability due to networking | ● | ● | ● | ● | ● |
| Remote operation of an existing fire detection system | — | — | — | — | ● |

- Preferred application
- Conditionally possible application
- Application not possible or not recommended

Fire control panels



You will find detailed information on the available control panel types and the available variants in the separate data sheet for the respective control panel type and in the system documentation. You will find information on the document ID of the documents in section 'Product documentation [→ 21]'.

| | FC722 | FC722 | FC723 | FC724 | FC726 |
|--|---|---|--|---|---|
| |  |  |  |  |  |
| Housing type | Standard | Comfort | Comfort | Comfort | Large |
| Supply | | | | | |
| Power supply | 70 W | 150 W | 150 W | 150 W | 150 W |
| Max. battery capacity | 12 Ah | 25 Ah | 25 Ah | 25 Ah | 45 Ah |
| Interfaces | | | | | |
| Slots for module bus cards | – | | 2 | – | 5 |
| Ethernet port RJ45 | 1 | | 1 | 1 | 1 |
| Inputs / outputs | | | | | |
| Number of integrated C-NET lines: | | | | | |
| • Loops (with loop extension) or | 2/4 | | 2/4 | 4/8 | 4/8 |
| • Stubs (with loop extension) | 4/8 | | 4/8 | 8/16 | 8/16 |
| Number of C-NET lines in addition to line cards: | | | | | |
| • Loops/stubs | – | | 2x 4/8 | – | 5x 4/8 |
| Max. number of C-NET addresses | 252 | | 756 | 504 | 1512 |

| | FC722 | FC722 | FC723 | FC724 | FC726 |
|--|--|--------------------|--------------------|--------------------|--------------------|
| Integrated outputs for alarm and control: | | | | | |
| • RT alarm relay | 1 | | 1 | 1 | 1 |
| • RT fault relay | 1 | | 1 | 1 | 1 |
| • Monitored alarm output | 1 | | 1 | 1 | 1 |
| • Monitored fault output | 1 | | 1 | 1 | 1 |
| Horn output, monitored (with sounder module) | 1/4 | | 1/8 | 2/8 | 2/8 |
| Configurable inputs/outputs 24 V | 8 | | 8 | 12 | 12 |
| Dimensions | | | | | |
| With cover cap/door | 430 x 398 x 103 mm | 430 x 796 x 188 mm | 430 x 796 x 188 mm | 430 x 796 x 188 mm | 430 x 796 x 288 mm |
| Without cover cap | 430 x 398 x 80 mm | 430 x 796 x 160 mm | 430 x 796 x 160 mm | 430 x 796 x 160 mm | 430 x 796 x 260 mm |
| Degraded mode and emergency supply | Yes | | | | |
| Emergency power supply | Emergency operation in degraded mode for up to 72 h (depending on configuration) | | | | |
| Organizational logic | The alarm verification concept (AVC) allows the control panels to be organized in accordance with customer requirements. | | | | |

| | FT724 |
|--------------------------------|--|
| Event memory | Up to 13000 events can be called up for each station based on various criteria. |
| Ground fault monitoring | All the outgoing detector lines running out from the control panels are monitored for ground faults. |

Accessories

You will find information on accessories and possible extensions in the separate data sheet for the respective control panel or terminal type and in the system documentation. You will find information on the document ID of the documents in section 'Product documentation [→ 21]'.

Device combinations

Hardware extensions



You will find detailed information on the hardware extensions and compatibilities in the separate data sheet for the respective control panel or terminal type and in the system documentation. You will find information on the document ID of the documents in section 'Product documentation [→ 21]'.

| Hardware extension | FC722 | FC723 | FC724 | FC726 | FT724 |
|---|-------|-------|-------|-------|-------|
| Network module (SAFEDLINK) FN2001-A1 | • | • | • | • | • |
| Repeater (SAFEDLINK) FN2002-A1 | • | • | • | • | • |
| Loop extension (FDnet) FCI2003-A1 | • | • | • | • | – |
| Line card (FDnet/C-NET) FCL2001-A1 | – | • | – | • | – |
| Line card (SynoLOOP) FCL7201-Z3 | – | • | – | • | – |
| I/O card (remote transmission) FCI2007-A1 | – | • | – | • | – |
| I/O card (programmable) FCI2008-A1 | – | • | – | • | – |
| I/O card (horn, monitored) FCI2009-A1 | – | • | – | • | – |
| Sounder module FCA2005-A1 | • | • | • | • | – |
| RS232 module (isolated) FCA2001-A1 | • | • | • | • | • |
| RS485 module (isolated) FCA2002-A1 | • | • | • | • | • |
| Fire brigade periphery module (DE) FCI2001-D1 | • | • | • | • | – |
| Extinguishing card XCI2005-A1 ¹ | • | – | • | – | – |
| Event printer FTO2001-A1 | • | • | • | • | • |
| Event printer DL3750+ | • | • | • | • | • |
| LED indicators | • | • | • | • | • |

- Extension possible
- Extension not possible

¹⁾ Installation is only possible if there is sufficient space in the housing.

Fire detector



- Fire detectors with the latest generation of evaluation algorithms.
- Signals are processed using **ASA technology™**.
- Time-dependent and process-dependent detection behavior.
- Maximum detection reliability thanks to unique detector properties.

Radio fire detection system



- Radio fire detection system with full integration into C-NET
- Wireless coupling with mesh technology
- Costly or visible cable installations are not required, which makes the radio fire detection system particularly useful for museums and churches
- Installation can be carried out without interrupting operation.
- Radio gateway FDCW241 communicates with up to 30 radio detectors (smoke detectors and manual call points), with up to 16 overlapping radio cells supported at each point.

Aspirating smoke detector



FDA221, FDA241

- This aspirating smoke detector is designed to detect smoke at a very early stage and is intended for protecting small areas that are classed as operationally critical.
- The detector continually sucks in air samples through extraction openings in a network of pipes.
- The air is supplied to a detection chamber where the presence of the smallest smoke particles can be detected using dual-wavelength technology or laser light.

Sounders and sounder bases (sounders, sounder beacons, voice sounders)



- Operation of the sounders and sounder bases on the C-NET detector line.
- Supply and communication via C-NET
- No costly additional cabling required
- Meets the requirements of the EN 54-3 standard
- Max. 16 tones to choose from, 2 programmable events: 'Warning (ALERT)' and 'Evacuation (EVAC)*'
- Optional: integrated beacon*; meets the requirements of the EN 54-23 standard
- Optional: additional voice output*:
 - 15 languages integrated in the device, additional languages can be ordered
 - Each voice message can be emitted in two languages
 - Max. seven available events
 - Customer-specific voice messages and/or tones can be ordered

* Only possible for certain types of sounders and sounder bases.

Input and output modules



- Statuses can be monitored using an input module, e.g., door monitors, fan controls, or for the activation of sprinkler alarms.
- Input/output modules are used for the decentralized controls of fire safety doors, fans, and similar applications.
- The inputs can be used for confirmation purposes, for monitoring statuses, or for controlling the standard extinguishing interface (SST) in accordance with VdS.
- The transponder has two inputs/outputs that can be configured for the following applications:
 - Connection of collective limit value detectors
 - Monitored control of alarm devices

Line separator



- A line separator ensures that multiple stub lines do not fail in the event of a short-circuit.
- The line separator is installed between two stubs on the C-NET if there are no other Cerberus PRO line devices between the stubs which can perform a line separation function.

Mimic display driver

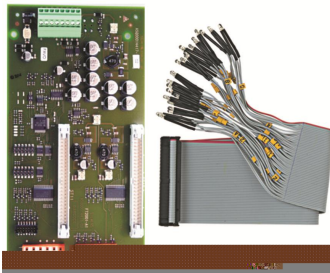

- The mimic display driver FT2001-A1 has 2x 24 outputs for controlling mimic display LEDs.
- Operation on the C-NET detector line
- Two control outputs for 'Local buzzer' and 'LED operation'
- Two inputs for 'Silence buzzer' and 'LED test'
- The LEDs are connected via a ribbon cable.

Floor repeater terminal and floor repeater display

- The floor repeater terminal FT2010 and the floor repeater display FT2011 are operated directly on the C-NET detector line.
- The floor repeater display FT2011 displays messages and events from selected areas of the fire detection system.
- The floor repeater terminal FT2010 displays messages and events from selected areas of the fire detection system and also enables operation.
- The responsible customer personnel (e.g., ward nurses) have access to a clear and well laid-out user interface. This displays customer-specific plain text messages to enable pinpointing of events.
- The display is of the same type as fire terminal FT724.

Details for ordering

You will find ordering information in the separate data sheet of the respective control panel or terminal type and in the system documentation. You will find information on the document ID of the documents in section 'Product documentation [→ 21]'.

Product documentation

| Title | Document ID |
|---|--------------|
| System documentation | |
| System description | A6V10210355 |
| Product data | A6V10210368 |
| Planning | A6V10210362 |
| Mounting/Installation | A6V10210390 |
| Data sheets | |
| FC721 - fire control panel | A6V10203220 |
| FC722 - fire control panel | A6V10206525 |
| FC723 - fire control panel for modernization | A6V10379246 |
| FC724 - fire control panel | A6V10207176 |
| FC726 - fire control panel (modular) | A6V10263277 |
| FT724 - fire terminal | A6V10207898 |
| Fire detection system with integrated single-sector extinguishing | A6V10880701 |
| Network Security Guidelines | A6V101039439 |
| Planning overview | A6V10332842 |

Related documents such as the environmental declarations, CE declarations, etc., can be downloaded from the following Internet address:

<https://siemens.com/bt/download>



Safety

| | |
|---|--|
|  | <p>⚠ CAUTION</p> |
| | <p>National safety regulations</p> <p>Failure to comply with national safety regulations may result in personal injury and property damage.</p> <ul style="list-style-type: none"> • Observe national provisions and comply with the appropriate safety regulations. |

Disposal

| | |
|---|---|
|  | <p>The device is considered an electronic device for disposal in accordance with the European Guidelines and may not be disposed of as domestic garbage.</p> <ul style="list-style-type: none"> • Dispose of the device through channels provided for this purpose. • Comply with all local and currently applicable laws and regulations. • Dispose of empty batteries in designated collection points. |
|---|---|

Guarantee

Technical data on specific applications are valid only together with Siemens products listed under "Equipment combinations". Siemens rejects any and all warranties in the event that third-party products are used.

Technical data

You will find information on the technical data of the individual fire control panels and fire terminals in the separate data sheet for the respective control panel or terminal type. You will find information on the document ID of the documents in section 'Product documentation [→ 21]'.