

Cerberus™ PRO

Fire control panel

FC723



Modular, pre-assembled fire control panel with integrated, user-friendly operating unit for gradual migration to Cerberus PRO.

- Fire control panel for a maximum of 756 addresses
- Can be used as a standalone version or networked with up to 64 stations, such as control panels and terminals
- Redundant network node with degraded mode operation according to EN 54
- Emergency power supply for emergency operating time of up to 72 hours
- Detection and automatic importing (auto-configuration) of all C-NET devices, ready for operation immediately
- Flexible configuration of complex applications and controls
- Configuration data can be uploaded/downloaded via remote access
- Extensions: Printer, key switches, LED indicators
- Card cage for additional module bus cards (line and I/O cards)
- Hot plug system: Module bus cards can be changed during operation

System



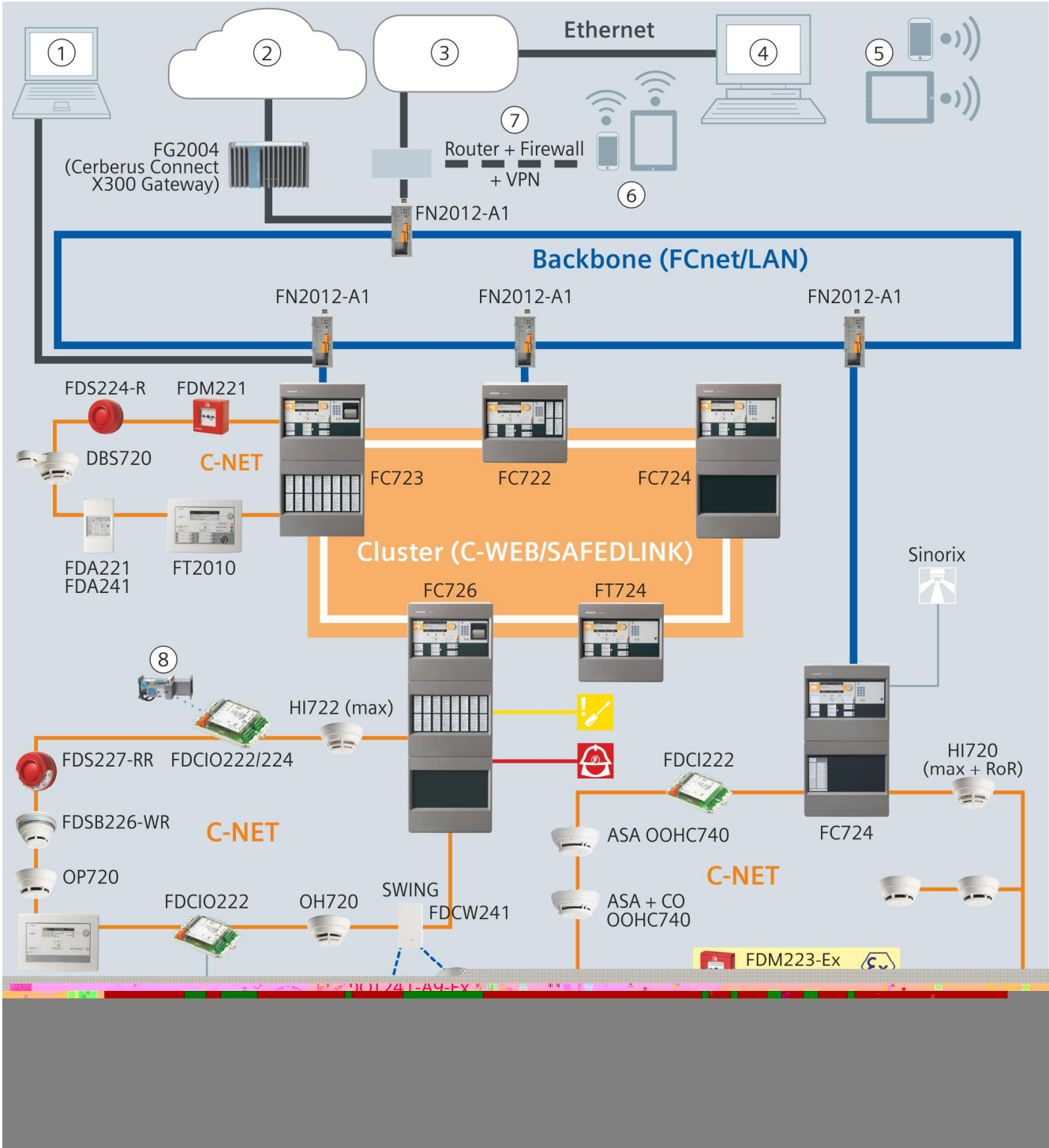

The diagrams have been simplified and do not include additional network hardware or security components. Permissible applications are described in the A6V101039439 Network Security Guidelines document. Contact your Siemens IT security expert for more information.

System overview



System overview

1	Remote access with Cerberus-Remote
2	FS cloud applications
3	Customer network
4	Management platform
5	Remote access to management platform
6	Remote access with Cerberus Mobile
7	Router + firewall + virtual private network
8	Fire damper with actuator
	Transmission of a fault signal
	Transmission of an alarm signal

You will find a detailed labeled version of the diagram above along with further information in the A6V10332842 planning guide, see chapter 'Product documentation'.

Optional module bus cards for card cage

Type	Designation	Properties
FCL2001-A1	Line card (FDnet/C-NET)	4x loops each with 252 addresses, max. of 252 addresses per line card
FCL7201-Z3	Line card (SynoLOOP)	4x loops each with a maximum of 128 addresses, max. of 512 addresses per line card
FCI2007-A1	I/O card (RT)	Outputs for alarm, fault, local alarm
FCI2008-A1	I/O card (programmable)	12x freely programmable inputs/outputs per I/O card
FCI2009-A1	I/O card (horn/monitored)	8x monitored horn outputs or monitored outputs

Networking of fire control panels



The diagrams have been simplified and do not include additional network hardware or security components. Permissible applications are described in the A6V101039439 Network Security Guidelines document. Contact your Siemens IT security expert for more information.

Up to 32 control panels and terminals can be linked to form one C-WEB network. If the C-WEB network is connected to a danger management system via BACnet, up to 16 control panels and terminals can be networked.

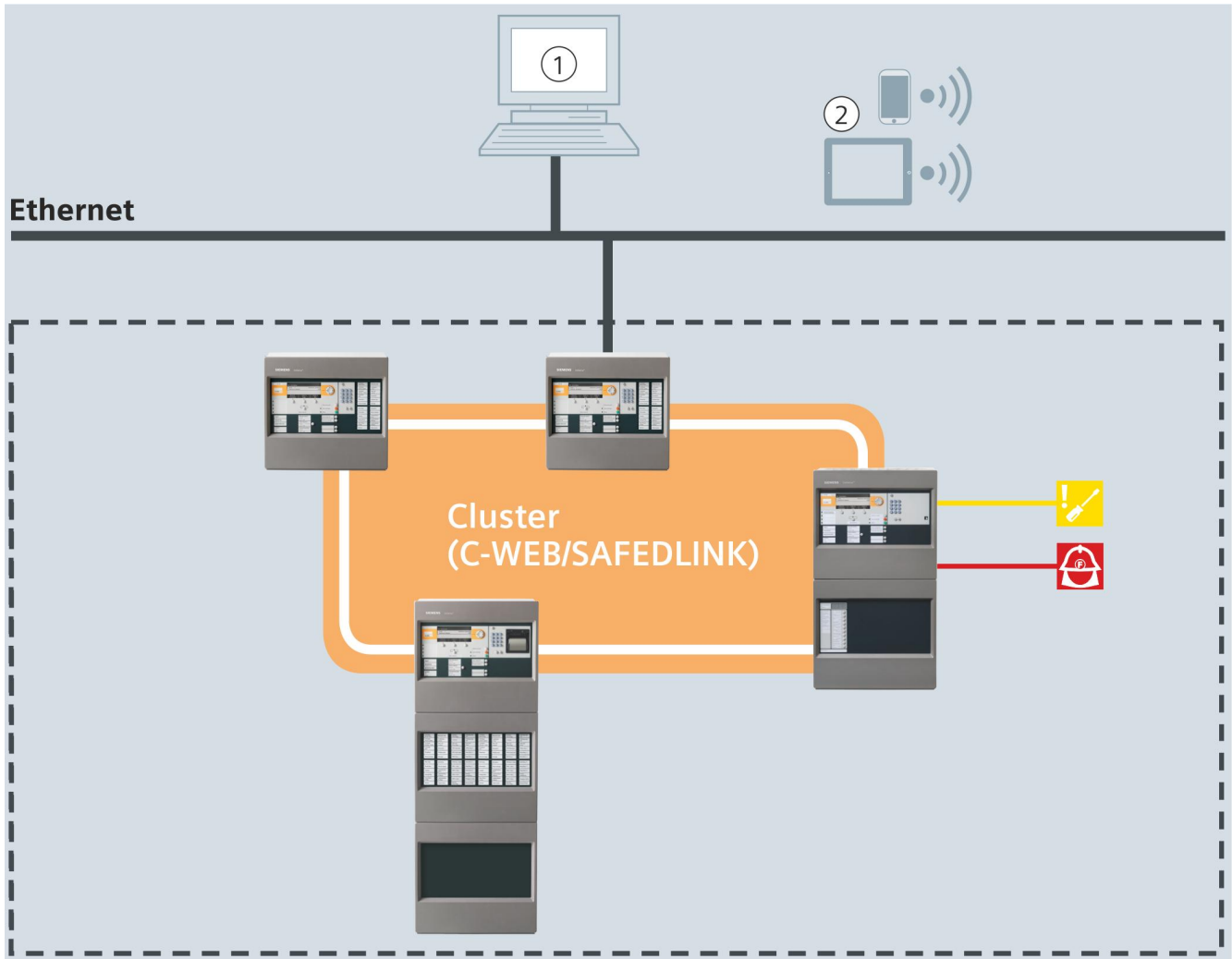



Sub-net

1	Management platform
2	Remote access to management platform
	Transmission of a fault signal
	Transmission of an alarm signal

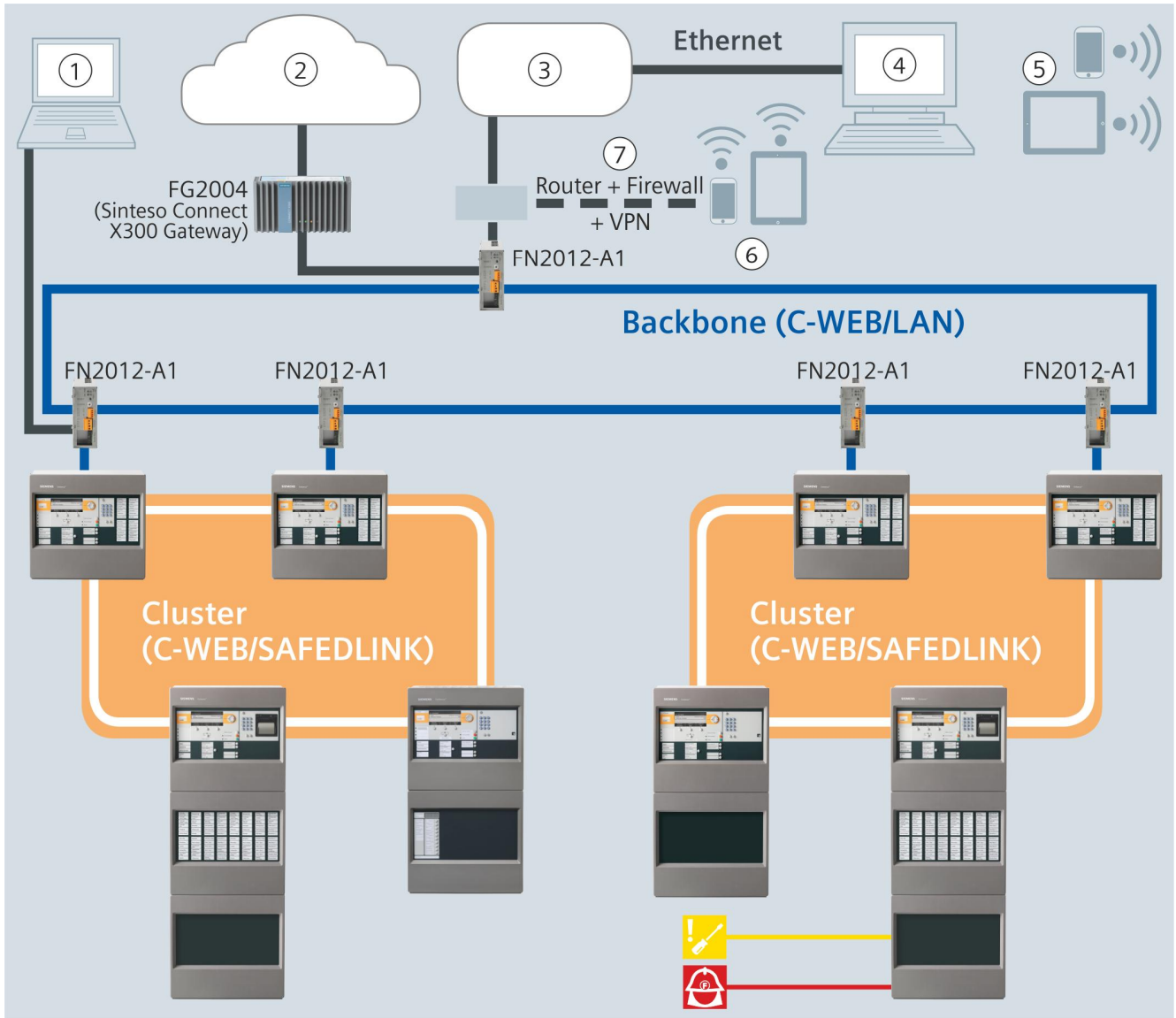
An optical C-WEB/LAN network allows up to 14 sub-nets with up to 16 stations to be operated in one network. A maximum of 64 stations is supported in total.



Backbone

1	Remote access with Cerberus-Remote
2	FS cloud applications
3	Customer network
4	Management platform
5	Remote access to management platform
6	Remote access with Cerberus Mobile
7	Router + firewall + virtual private network
	Transmission of a fault signal
	Transmission of an alarm signal

You will find a detailed labeled version of the diagram above along with further information in the A6V10332842 planning guide, see chapter 'Product documentation'.



General features and functions

- Fast Ethernet interface for a heterogeneous network
- Processes signals from Cerberus PRO as well as from earlier detector series
- Siemens danger management system can be connected
- Slots for RS232 and RS485 serial interfaces
- Floor repeater devices, alarm devices, and mimic displays on the C-NET detector line
- All detector lines are monitored for ground faults.
- Mixed use of all module bus cards (line and I/O cards) possible.
- Integrated degraded mode function
- Freely configurable, time-dependent controls with optional weekly switching programs
- Time and situation-dependent changeover of detector parameter sets
- Controls for synchronous activation of sounders / sounder bases with signal sound, flash, and voice output
- The control panel and the fire detection system are custom-configured using the 'Cerberus-Engineering-Tool' software
- Firmware for all processor-controlled control panel components can be updated
- Customer texts can be adapted directly on the operating unit of the control panel or with the 'Cerberus-Engineering-Tool' software
- Up to 13000 events can be called up from the event memory and filtered based on various criteria
- Automatic summer/normal time changeover

Control panel-specific features

<p>FC723-ZA</p>	<p>Housing (Comfort)</p>
	<p>C-NET detector line:</p> <ul style="list-style-type: none"> • 756 addresses • 2 loops/4 stubs • Can be extended with 2 module bus cards <p>Installable module bus cards (option):</p> <ul style="list-style-type: none"> • Line card (FDnet/C-NET) FCL2001-A1 • Line card (SynoLOOP) FCL7201-Z3 • I/O card (programmable) FCI2008-A1 • I/O card (horn/monitored) FCI2009A1 • I/O card (remote transmission) FCI2007-A1 <p>Features:</p> <ul style="list-style-type: none"> • Operating unit • Operating add-on (empty) • Card cage (2 slots) • 150 W power supply • Max. battery capacity 25 Ah <p>Operating unit options:</p> <ul style="list-style-type: none"> • Event printer FTO2001-A1 • Key switch (Kaba) FTO2005-C1 • Key switch (nordic) FTO2006-B1 • Operating add-on (2xLED indicator) FCM7213-Y3 • Operating add-on (4xLED indicator) FCM7214-Y3

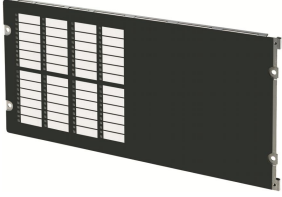
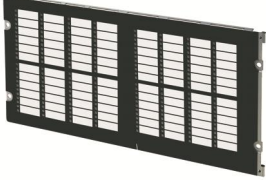
Extensions

<p>FCM7213-Y3</p> 	<p>Operating add-on (2xLED indicator)</p> <ul style="list-style-type: none"> Optional operating add-on with 48 indicator groups with one red/green + one yellow LED each
<p>FCM7214-Y3</p> 	<p>Operating add-on (4xLED indicator)</p> <ul style="list-style-type: none"> Optional operating add-on with 96 indicator groups with one red/green + one yellow LED each
<p>FH7203-Z3</p> 	<p>Housing (Comfort)</p> <ul style="list-style-type: none"> Empty housing for free use 430 x 796 x 183 mm E.g., for extra batteries, operating add-ons, or event printers Space for the following battery configurations: <ul style="list-style-type: none"> – 2x FA2003-A1 (7 Ah) or – 2x FA2004-A1 (12 Ah) or – 2x FA2005-A1 (17 Ah) or – 2x BAT12-25 (25 Ah)

FH7205-Z3	Housing (Large)
	<ul style="list-style-type: none"> • Empty housing for free use • 430 x 796 x 283 mm • E.g., for extra batteries, operating add-ons, or event printers • Space for the following battery configurations: <ul style="list-style-type: none"> – 4x BAT12-25 (25 Ah) or – 4x FA2007-A1 (45 Ah) or – 2x FA2008-A1 (65 Ah)

FTO2001-A1	Event printer
	<ul style="list-style-type: none"> • Thermal printer for installation in operating units or operating add-ons • Can be controlled via the RS232 module FCA2001-A1 (order separately) • Logs all important events, such as alarms, faults, isolations, and test functions

DL3750+	Matrix printer (external)
	<ul style="list-style-type: none"> • External matrix printer recommended by Siemens • Supports monitoring for printing faults • Can be controlled via the RS232 module FCA2001-A1 (order separately) • Can be controlled via Ethernet via the print server PS104 from SEH

This fire control panel is ideal for medium-sized applications, e.g., for use in industrial plants, regional banks, or office complexes.

Within the context of modernization, the Station allows a gradual and seamless transition from older systems to Cerberus PRO.

Function elements

Operating unit

The following elements are available on the operating unit:

- CPU module and electronics
- Ethernet connection
- Slots for RS232 and RS485 modules and network modules (SAFEDLINK)
- Space for 'Kaba' or 'nordic' key switch
- Space for event printer (depending on version)
- Peripheral data bus connection for optional LED modules

Periphery board

The following elements are available on the periphery board:

- Connection terminals for:
 - C-NET lines
 - Remote transmission (alarm, fault)
 - Horn output
 - Configurable control inputs and outputs
 - Monitored alarm and fault output
 - Power supply and emergency supply
- 1x slot for loop extension (C-NET)

Card cage

There is a card cage mounted on the rear housing panel for inserting a maximum of two module bus cards.

Power supply unit 150 W, emergency power supply

The power supply feeds the hardware and charges the batteries.

In the event of a power cut, the batteries provide emergency current.

Housing

A pivoting mounting plate can be fitted for the following elements above the periphery board on the rear housing panel:

- 1x fire brigade periphery module (for Germany)
- 1x sounder module (as an alternative to mounting on U-rail TS35)

Configuration

The following software allows the system to be customized:

- Cerberus-Engineering-Tool

Operation

Each control unit has an integrated operating unit. The control panel can also be operated via a separate fire terminal FT724.

You will find details and more information in product data sheet A6V10207898.

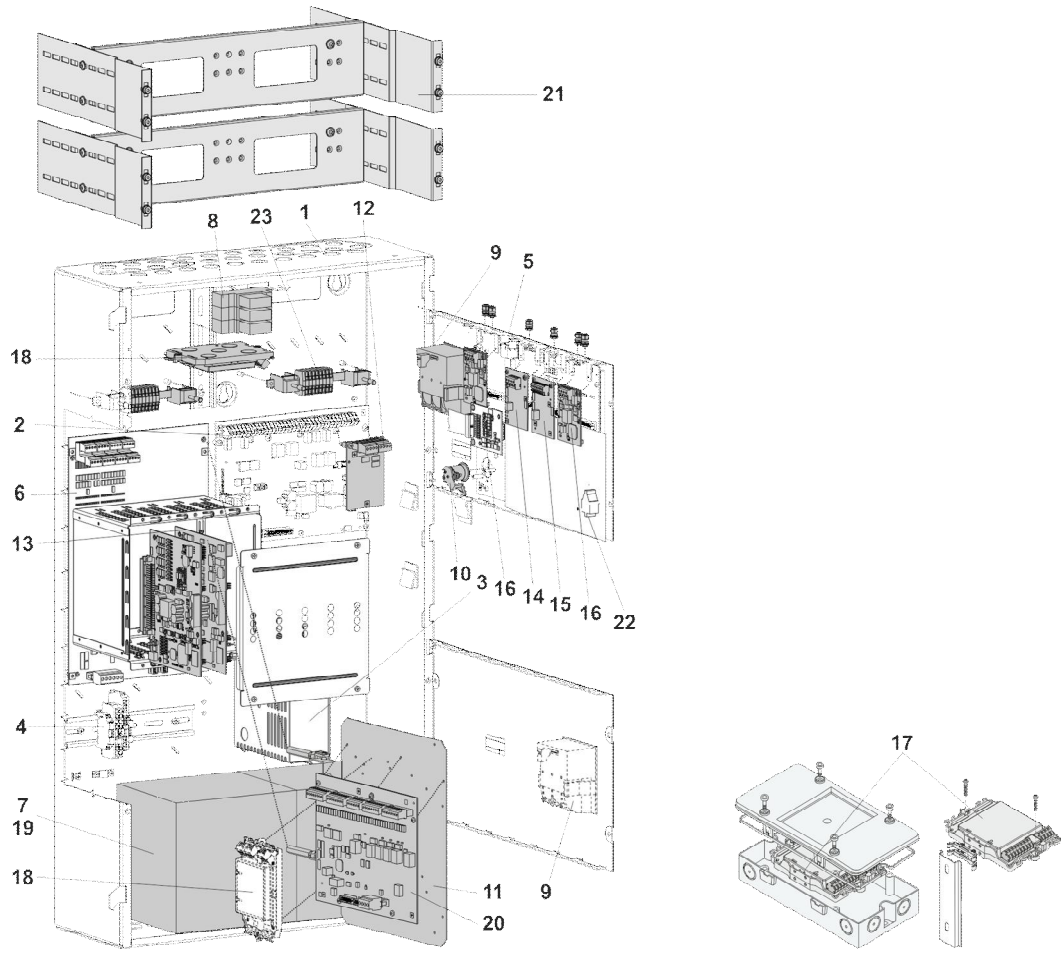

Layout of FC723

Position	Designation	Type	Comment
Basic equipment			
1	Housing (Comfort)	FH7203-Z3	Items 1-6: Basic equipment
2	Periphery board (2-loop)	FCI2002-A1	
3	Power supply (SV 24 V-150 W)	V24230-Z6-A5	
4	Mains terminals on TS35 DIN rail	-	Space for socket, relay modules, etc.
5	Operating unit	FCM72xx-xx	Operating unit with CPU
6	Card cage (2 slots)	FCA2008-A1	For two module bus cards
7	Space for batteries	-	2x 12 V / 17... 25 Ah
Extensions			
8	Relay module	Z3B171	Relay for fire controls
9	Event printer	FTO2001-A1	For logging events
10	Key switch (Kaba)	FTO2005-C1	For operating access authorization
	Key switch (nordic)	FTO2006-B1	
11	Mounting plate	FHA2007-A1	E.g., for fire brigade periphery module
12	Loop extension (C-NET)	FCI2003-A1	For extending the number of loops from two to four, the number of addresses remains the same
13	Module bus cards:		
	Line card (FDnet/C-NET)	FCL2001-A1	For four extra C-NET lines
	Line card (SynoLOOP)	FCL7201-Z3	For four addressable SynoLOOP lines
	I/O card (programmable)	FCI2008-A1	For twelve configurable inputs/outputs
	I/O card (horn/monitored)	FCI2009-A1	For eight monitored horn outputs
	I/O card (RT)	FCI2007-A1	For extra alarm and fault outputs
14	RS485 module (isolated)	FCA2002-A1	For peripheral devices with RS485 interface
15	RS232 module (isolated)	FCA2001-A1	For devices with an RS232 interface
16	Network module (SAFEDLINK)	FN2001-A1	For networking several stations
17	Repeater (SAFEDLINK)	FN2002-A1	For extending the C-WEB system bus, max. 1x repeater (SAFEDLINK) between two stations (mounted directly on a plane surface, on a TS35 U-rail, or in housing FDCH221)
18	Sounder module	FCA2005-A1	For splitting one conventional sounder into four
19	Battery (12 V, 17 Ah, VdS)	FA2005-A1	For the emergency power supply
	Battery (12 V, 25 Ah, VdS)	BAT12-25	
20	Fire brigade periphery module	FCI2001-D1	For Germany (FBF, FSD, ÜE, FSE, ÖA, KL)
21	19" mounting kit	FHA2016-A1	For installation in 19" third-party housing
22	License key Sx	FCA20xx	For special functions
23	Cable kit (communication)	FCA2014-A1	For flexible connections running to the modules on the operating unit

	Housing (Comfort)
	 <p>The image shows a Siemens Cerberus fire alarm control panel. The top section features a color LCD display showing 'SET Information' with fields for 'Area 1' and 'Reference to busbar'. Below the display are several control buttons: 'Emergency', 'Jump to Area', 'Jump to Exit', 'Silence buzzer', 'Acknowledge', and 'Reset'. A numeric keypad is located on the right side. The bottom section of the panel contains a large, dark rectangular area, likely a secondary display or a blank space for a label.</p>
Type	FC723-ZA
Order number	S54400-C143-A1
Number of C-NET addresses	756
Loops (with loop extension) or	2 (4)
Stubs (with loop extension)	4 (8)
Power supply	150 W
Max. battery capacity	25 Ah
Max. number of module bus cards in the card cage	2

Control panel

Type	Designation	Weight	Order number
FC723-ZA	Fire control panel (modular)	16.495 kg	S54400-C143-A1

Extensions

Type	Designation	Weight	Order number
FCA2001-A1	RS232 module (isolated)	0.033 kg	A5Q00005327
FCA2002-A1	RS485 module (isolated)	0.027 kg	A5Q00009923
FCA2005-A1	Sounder module	0.100 kg	A5Q00014866
FCA2014-A1	Cable kit (communication)	0.126 kg	A5Q00023027
FCI2001-D1	Fire brigade periphery module	0.207 kg	A5Q00013100
FCI2003-A1	Loop extension (C-NET)	0.030 kg	A5Q00010136
FCI2007-A1	I/O card (RT)	0.111 kg	S54400-A20-A1
FCI2008-A1	I/O card (programmable)	0.097 kg	S54400-A6-A1
FCI2009-A1	I/O card (horn, monitored)	0.109 kg	S54400-A21-A1
FCL2001-A1	Line card (FDnet/C-NET)	0.119 kg	A5Q00009875
FCL7201-Z3	Line card (SynoLOOP)	0.120 kg	S54400-A116-A1
FCM7213-Y3	Operating add-on (2xLED indicator)	2.516 kg	S54400-B149-A1
FCM7214-Y3	Operating add-on (4xLED indicator)	3.905 kg	S54400-B150-A1
FH7202-Z3	Housing (Standard)	7.268 kg	S54400-B70-A1
FH7203-Z3	Housing (Comfort)	12.874 kg	S54400-B71-A1
FH7204-Z3	Housing (Large Extension)	11.729 kg	S54400-B89-A1
FH7205-Z3	Housing (Large)	16.079 kg	S54400-B86-A1
FHA2007-A1	Mounting plate	0.800 kg	A5Q00010151
FHA2016-A1	19" mounting kit	3.000 kg	A5Q00020179
FN2001-A1	Network module (SAFEDLINK)	0.022 kg	A5Q00012851
FN2002-A1	Repeater (SAFEDLINK)	0.105 kg	S24236-B2502-A1
FN2006-A1	Fiber network module (SM)	0.792 kg	S54400-A109-A1
FN2007-A1	Fiber network module (MM)	0.792 kg	S54400-A110-A1
FTO2001-A1	Event printer	0.141 kg	A5Q00010126
-	Spare printer reels (10 reels)	0.090 kg	A5Q00017619
FTO2005-C1	Key switch (Kaba)	0.083 kg	A5Q00010113
FTO2006-B1	Key switch (nordic)	0.046 kg	A5Q00010129
Z3B171	Relay module 250 V AC / 10 A (1 relay)	0.042 kg	4843830001

Auxiliary power supply

Type	Designation	Weight	Order number
FP2004-A1	Power supply kit (150 W, A) for EN-compliant installation in empty housing	1.286 kg	A5Q00020825
FP2005-A1	Power supply kit (150 W, B) for extension	1.181 kg	A5Q00018779

Network (backbone)

Type	Designation	Weight	Order number
FCA2031-A1	Connection module (MoNet)	0.081 kg incl. cable	S54400-A153-A1
FHA2029-A1	Mounting kit (switch)	1.261 kg	S54400-B79-A1
FN2012-A1	Ethernet switch (modular)	0.600 kg	S54400-B152-A1
VN2002-A1	Ethernet module (MM)	0.026 kg	S54400-A43-A1
VN2003-A1	Ethernet module (SM)	0.026 kg	S54400-A44-A1

Batteries

Type	Designation	Weight	Order number
FA2003-A1	Battery (12 V, 7 Ah, VdS)	2.350 kg	A5Q00019353
FA2004-A1	Battery (12 V, 12 Ah, VdS)	3.750 kg	A5Q00019354
FA2005-A1	Battery (12 V, 17 Ah, VdS)	5.700 kg	A5Q00019677
BAT12-25	Battery (12 V, 25 Ah, VdS)	7.8 kg	S54302-Z102-A1
FA2007-A1	Battery (12 V, 45 Ah, VdS)	14.500 kg	A5Q00022897
FA2008-A1	Battery (12 V, 65 Ah, VdS)	21.300 kg	A5Q00019357
FHA2061-A1	Mounting kit (batteries)	–	S54400-B91-A1

License keys

Type	Designation	Weight	Order number
FCA2033-A1	License key (S1)	0.010 kg	S54400-P154-A1
FCA2034-A1	License key (S2)	0.010 kg	S54400-P155-A1
FCA2035-A1	License key (S3)	0.010 kg	S54400-P156-A1
FCA2036-A1	License key (S4)	0.010 kg	S54400-P157-A1

External printer

Type	Designation	Weight	Order number
DL3750+	Matrix printer (external)	7.300 kg	A5Q00023962
-	Color ribbon for matrix printer DL3750+	0.078 kg	A5Q00023963

Product documentation

Title	Document ID
System documentation	
System description	A6V10210355
Product data	A6V10210368
Planning	A6V10210362
Mounting/Installation	A6V10210390
Data sheets	
FC721 - fire control panel	A6V10203220
FC722 - fire control panel	A6V10206525
FC723 - fire control panel for modernization	A6V10379246
FC724 - fire control panel	A6V10207176
FC726 - fire control panel (modular)	A6V10263277
FT724 - fire terminal	A6V10207898
Fire detection system with integrated single-sector extinguishing	A6V10880701
Network Security Guidelines	A6V101039439
Planning overview	A6V10332842

Related documents such as environmental declarations, CE declarations, etc., can be downloaded at the following Internet address:

<http://siemens.com/bt/download>

Guarantee

Technical data on specific applications are valid only together with Siemens products listed under "Equipment combinations". Siemens rejects any and all warranties in the event that third-party products are used.

FC723 in the housing (Comfort)	
Supply	
Mains voltage	AC 115/230 V +10/-15 %
Power supply	150 W
Operating voltage	DC 21...28.4 V
Operating current	Max. 5 A
Battery capacity	2x 12 V, 7...25 Ah
Battery monitoring	Yes
Network monitoring	Yes
Inputs / outputs	
Connectable detector series	Cerberus PRO
Other addressable detectors which can be connected	SynoLOOP
Number of addresses	Max. 756
Number of integrated line cards	1
Number of integrated lines:	
• Loops (with loop extension) or	2 (4)
• Stubs	4 (8)
Number of additional lines:	
• C-NET (4 loops per line card)	Max. 8 loops
• SynoLOOP (4 loops or stubs per line card)	Max. 8 loops/stubs
Integrated inputs/outputs:	
• Alarm RT relay output	1
• Fault RT relay output	1
• Monitored alarm outputs	1
• Monitored fault outputs	1
• Monitored horn outputs	1
• Freely programmable inputs/outputs	8
Additional I/O cards:	
• Programmable	12x configurable inputs/outputs 2x supply outputs 24 V
• Horn/monitored	8x horn output monitored
• RT	1x alarm relay output 1x fault relay output 1x voltage output 24 V 2x GPIO 1x fault output monitored 2x configurable output monitored

FC723 in the housing (Comfort)	
Interfaces	
Operating unit	Integrated
Slots for serial interfaces RS232, RS485	2
Slots for network modules	2
Slot for loop extension	1
Slots for module bus cards (on integrated card cage)	2
Mounting spaces for cable kit (communication)	2
Sounder module	Max. 1
Ethernet port RJ45	1
Ambient conditions	
Operating temperature	-8...+42 °C
Storage temperature	-20...+60 °C
Air humidity (no condensation permitted)	≤95 % rel.
Maximum height above sea level	3700 m
Mechanical data	
Dimensions (W x H x D):	
• Without cover cap	430 x 796 x 160 mm
• With cover cap	430 x 796 x 183 mm
Protection category (IEC 60529)	IP30
Color:	
• Housing	~RAL 7035 light gray
• Cover cap	~RAL 000 50 00
Approvals	
VdS	G214021
LPCB	126bn/09

14  0786	FC723-ZA	Siemens Schweiz AG; Theilerstrasse 1a CH-6300 Zug Technical data: see doc. A6V10210355
FC723 - Control and Indicating Equipment incl. SV24V150W - 150W/24VDC Power Supply Equipment for use in fire detection and fire alarm systems installed in buildings.		
305/2011/EU (CPR): EN 54-2 / EN 54-4 ; 2014/30/EU (EMC): EN 50130-4 / EN 61000-6-3 ; 2014/35/EU (LVD): EN 60950-1 ; 2011/65/EU (RoHS): EN 50581		
The declared performance and conformity can be seen in the Declaration of Performance (DoP) and the EU Declaration of Conformity (DoC), which is obtainable via the Customer Support Center: Tel. +49 89 9221-8000 or http://siemens.com/bt/download		
DoP No.: 0786-CPR-21328; DoC No.: CED-FC723		

13  0786	SV24V150W	Siemens Schweiz AG; Theilerstrasse 1a CH-6300 Zug Sinteso technical data: see doc. 008837 Cerberus™ PRO technical data: see doc. A6V10210368
SV24V150W - Power Supply Equipment 24VDC/150W for use in fire detection and fire alarm systems installed in buildings.		
305/2011/EU (CPR): EN 54-4 ; 2014/30/EU (EMC): EN 50130-4 / EN 61000-6-3 ; 2014/35/EU (LVD): EN 60950-1 ; 2011/65/EU (RoHS): EN 50581		
The declared performance and conformity can be seen in the Declaration of Performance (DoP) and the EU Declaration of Conformity (DoC), which is obtainable via the Customer Support center: Tel. +49 89 9221-8000 or http://siemens.com/bt/download		
DoP No.: 0786-CPD-20775; DoC No.: CED-SV24V150W		

Issued by
Siemens Switzerland Ltd
Building Technologies Division
International Headquarters
Theilerstrasse 1a
CH-6300 Zug
Tel. +41 58 724 2424
www.siemens.com/buildingtechnologies

© Siemens Switzerland Ltd, 2007
Technical specifications and availability subject to change without notice.